

FOR CAR USE ONLY/NUR FÜR AUTOMOBILGEBRAUCH/POUR APPLICATION AUTOMOBILE
UNIQUEMENT/SOLO PARA USO EN AUTOMÓVILES/PER IL SOLO UTILIZZO IN AUTOMOBILE

ALPINE®

**Alpine Style Solution for Audi A4, A5, Q5
X703D-A**



**Supplement to Owner's Manual
Ergänzung zur Bedienungsanleitung
Supplément au Manuel d'utilisation
Supplemento al Manuale d'uso
Suplemento al Manual de Operación**

Getting Started

Location of Controls

■ For X703D-A

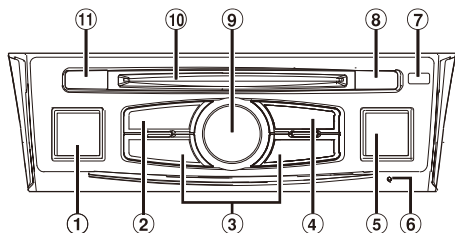



- ①** **(AUDIO)/(Favourite) button**
Displays the Audio/Visual screen. If the Audio/Visual screen is already displayed, changes the source. Press and hold for at least 2 seconds to recall the Favourite screen.
- ②** **or VOICE button**
Depending on the connected smartphone, press to recall Siri function or voice recognition mode.
- ③** **button**
Press to seek up/down a station in radio mode or up/down a track, chapter, etc., in other audio/visual sources.
- ④** **MENU/ (Power Off) button**
Recalls the Menu screen.
Press and hold this button for at least 5 seconds to turn the power off.
- ⑤** **(NAV) button**
Recalls the navigation map screen.
Press again to switch to Navigation menu screen.
Press and hold this button for at least 2 seconds to change to Go Home route screen. (If Home is not set yet, it will change to the Home setting screen.)
For details of navigation operations, refer to "Navigation System OM" in the CD-ROM.
- ⑥** **RESET switch**
The system of this unit is reset.
- ⑦** **Remote Sensor**
Point the remote control transmitter towards the remote sensor within a range of 2 metres.
- ⑧** **(Eject) button (only with DVE-5300X)**
Ejects a disc.
- ⑨** **Rotary encoder/MUTE button**
Adjust the volume by turning to the left or right. Press to activate /deactivate MUTE mode.
- ⑩** **Disc Slot (only with DVE-5300X)**
- ⑪** **CAM (CAMERA)**
Use to display the camera image.

Erste Schritte

Lage und Funktion der Teile und Bedienelemente

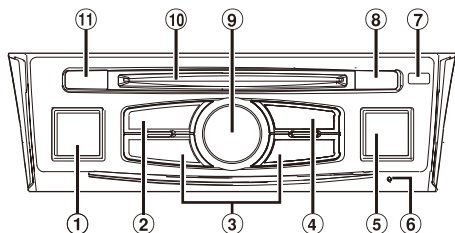
■ X703D-A







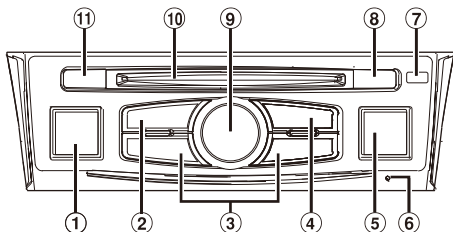

- ① **Taste  (AUDIO)/(Favoriten)**
 Ruft den Audio-/Video-Bildschirm auf. Wenn der Audio-/Video-Bildschirm bereits angezeigt wird, wird die Signalquelle gewechselt.
 Halten Sie die Taste mindestens 2 Sekunden lang gedrückt, um den Favoritenbildschirm aufzurufen.
- ② **Taste  oder VOICE**
 Abhängig vom angeschlossenen Smartphone rufen Sie durch Drücken die Siri-Funktion oder den Spracherkennungsmodus auf. .
- ③ **Taste **
 Drücken Sie diese Taste, um im Radiomodus vorwärts/rückwärts nach einem Sender zu suchen bzw. in einer anderen Audio-/Videoquelle ein Stück, ein Kapitel usw. vorwärts/rückwärts zu suchen.
- ④ **Taste MENU/(Ausschalten)**
 Ruft den Menübildschirm auf.
 Halten Sie diese Taste mindestens 5 Sekunden gedrückt, um das Gerät auszuschalten.
- ⑤ **Taste  (NAV)**
 Ruft den Navigationskartenbildschirm auf.
 Drücken Sie die Taste erneut, um zum Navigations-Menübildschirm zu wechseln.
 Halten Sie diese Taste mindestens 2 Sekunden lang gedrückt, um zum Heimatadressen-Routenbildschirm zu wechseln. (Ist noch keine Heimatadresse eingestellt, erscheint der Bildschirm zum Einstellen der Heimatadresse.)
 Einzelheiten zu den Navigationsfunktionen finden Sie in der „Anleitung zum Navigationssystem“ auf der CD-ROM.
- ⑥ **RESET-Schalter**
 Das Gerätesystem wird zurückgesetzt.
- ⑦ **Fernbedienungssensor**
 Richten Sie die Fernbedienung in einem Abstand von maximal 2 Metern auf diesen Sensor.
- ⑧ **Taste  (Auswerfen) (Nur mit DVE-5300X)**
 Zum Auswerfen einer Disc.
- ⑨ **Drehregler/ Taste MUTE**
 Zum Einstellen der Lautstärke durch Drehen nach links oder rechts.
 Durch Drücken aktivieren/deaktivieren Sie den Stummmodus.
- ⑩ **Disc Einschub (only with DVE-5300X)**
- ⑪ **Taste  CAM (CAMERA)**
 Zum Anzeigen des Kamerabildes.

Mise en route

Emplacement des commandes

■ X703D-A



- ① Bouton  (AUDIO)/(Favoris)**
Ce bouton permet d'afficher l'écran Audio/Visuel. Si l'écran Audio/Visuel est déjà affiché, ce bouton permet de changer de source.
Maintenez enfoncé ce bouton pendant au moins 2 secondes pour rappeler l'écran Favoris.
- ② Bouton  ou VOICE**
Selon le smartphone connecté, appuyez pour rappeler la fonction Siri ou le mode reconnaissance vocale.
- ③ Bouton **
Appuyez sur ce bouton pour rechercher la station suivante/précédente en mode radio ou la piste, le chapitre, etc., suivant/précédent dans une autre source Audio/Visuel.
- ④ Bouton MENU/(mise hors tension)**
Ce bouton permet de rappeler l'écran Menu.
Appuyez dessus pendant au moins 5 secondes pour mettre l'appareil hors tension.
- ⑤ Bouton  (NAV)**
Ce bouton permet de rappeler l'écran des cartes de navigation.
Appuyez une nouvelle fois sur ce bouton pour passer à l'écran du menu de navigation.
Appuyez sur ce bouton pendant au moins 2 secondes pour passer à l'écran de l'itinéraire de retour au domicile. (Si cet itinéraire n'est pas encore défini, l'écran de configuration de l'adresse du domicile s'affiche.)
Pour plus d'informations sur les fonctions de navigation, consultez la section « Système de navigation OM » sur le CD-ROM.
- ⑥ Commutateur RESET**
Appuyez sur ce bouton pour réinitialiser le système.
- ⑦ Capteur Télécommande**
Dirigez la télécommande vers ce capteur dans un champ de portée de 2 mètres.
- ⑧ Bouton  (Ejection) (DVE-5300X uniquement)**
Ce bouton permet d'éjecter les disques.
- ⑨ Bouton rotatif/bouton SILENCIEUX**
Réglez le volume en tournant ce bouton vers la gauche ou vers la droite.
Appuyez sur ce bouton pour activer/désactiver le mode SILENCIEUX.
- ⑩ Logement pour disque (avec DVE-5300X uniquement)**
- ⑪ Bouton  CAM (CAMERA)**
Utilisez ce bouton pour afficher les images de la caméra.

Informazioni preliminare

Posizione dei comandi

■ X703D-A

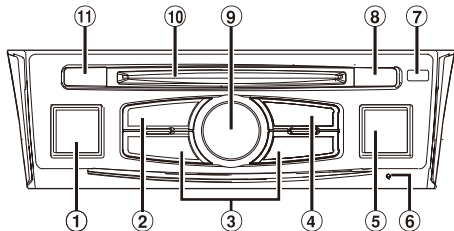







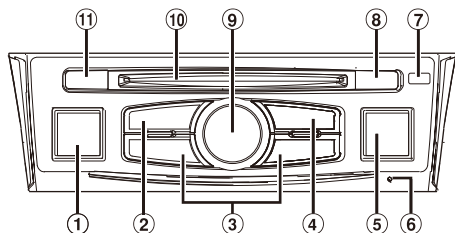

- ① Tasto (AUDIO)/(Preferiti)**
Consente di visualizzare la schermata Audio/Video. Se la schermata Audio/Video è già visualizzata, consente di cambiare la sorgente. Tenerlo premuto per almeno 2 secondi per richiamare la schermata Preferiti.
- ② Tasto o VOICE**
A seconda dello smartphone collegato, premerlo per richiamare la funzione Siri o la modalità di riconoscimento vocale.
- ③ Tasto**
Pulse este botón para buscar ascendentemente o descendentemente una emisora en el modo de radio o para avanzar o retroceder una pista, un capítulo, etc., en otras fuentes de audio/visuales.
- ④ Tasto MENU/(Spegnimento)**
Consente di visualizzare la schermata Menu. Tenere premuto questo pulsante per almeno 5 secondi per spegnere l'unità.
- ⑤ Tasto (NAV) button**
Consente di visualizzare la schermata con la mappa di navigazione. Premere di nuovo per passare alla schermata del menu Navigazione. Tenere premuto questo pulsante per almeno 2 secondi per passare alla schermata per percorso Torna a casa (se non è ancora stato impostato un indirizzo Casa, verrà visualizzata la schermata di impostazione Casa). Per informazioni dettagliate sulle operazioni di navigazione, consultare "Sistema di navigazione OM" disponibile sul CD-ROM.
- ⑥ Interruttore RESET**
Consente di resettare il sistema dell'unità.
- ⑦ Sensore remoto**
Puntare il trasmettitore del telecomando verso il sensore remoto da una distanza inferiore a 2 metri.
- ⑧ Tasto (Espelli)**
Consente di espellere un disco.
- ⑨ Manopola di selezione/pulsante DISATTIVAZIONE AUDIO**
Ruotare a sinistra o a destra per regolare il volume. Premere per attivare/disattivare l'audio.
- ⑩ Fessura per disco (solo con DVE-5300X)**
- ⑪ Tasto CAM (TELECAMERA)**
Consente di visualizzare l'immagine della telecamera.

Primeros pasos

Ubicación de los controles

■ X703D-A



- 1 Botón  AUDIO)/(Favoritos)**
Muestra la pantalla Audio/Visual. Si la pantalla Audio/Visual ya está visible, cambia la fuente. Mantenga pulsado durante al menos 2 segundos para acceder a la pantalla de Favoritos.
- 2 Botón  o VOICE**
Dependiendo del smartphone conectado, pulse para acceder a la función de volumen del Siri o al modo de reconocimiento de voz.
- 3 Botón  / **
Pulse este botón para buscar ascendente o descendente una emisora en el modo de radio o para avanzar o retroceder una pista, un capítulo, etc., en otras fuentes de audio/visuales.
- 4 Botón MENU/(Apagado)**
Accede a la pantalla de menús. Pulse este botón durante al menos 5 segundos para apagar la unidad.
- 5 Botón  (NAV)**
Accede a la pantalla del mapa de navegación. Vuelva a pulsar el botón para cambiar a la pantalla del menú de navegación. Pulse este botón durante al menos 2 segundos para cambiar a la pantalla de la ruta para regresar a su domicilio. (Si aún no ha definido ninguna ubicación como su domicilio, cambiará a la pantalla que permite configurar su domicilio como ubicación predeterminada.)
Para obtener más información sobre las operaciones de navegación, consulte el "Manual de operación del sistema de navegación" incluido en el CD-ROM.
- 6 Interruptor RESET**
Reinicia el sistema de esta unidad.
- 7 Sensor remoto**
Apunte el transmisor del mando a distancia hacia el sensor remoto desde una distancia máxima de 2 metros..
- 8 Botón  (Expulsar) (solo con DVE-5300X)**
Expulsa un disco.
- 9 Codificador giratorio/botón MUTE**
Permite ajustar el volumen girando a la izquierda o a la derecha. Pulse este botón para activar/desactivar el modo de SILENCIAMIENTO.
- 10 Ranura para discos (solo con DVE-5300X)**
- 11 Botón  CAM (CAMERA)**
Se utiliza para visualizar la imagen de la cámara..

Connections/ Anschlüsse Conexiones/ Collegamenti

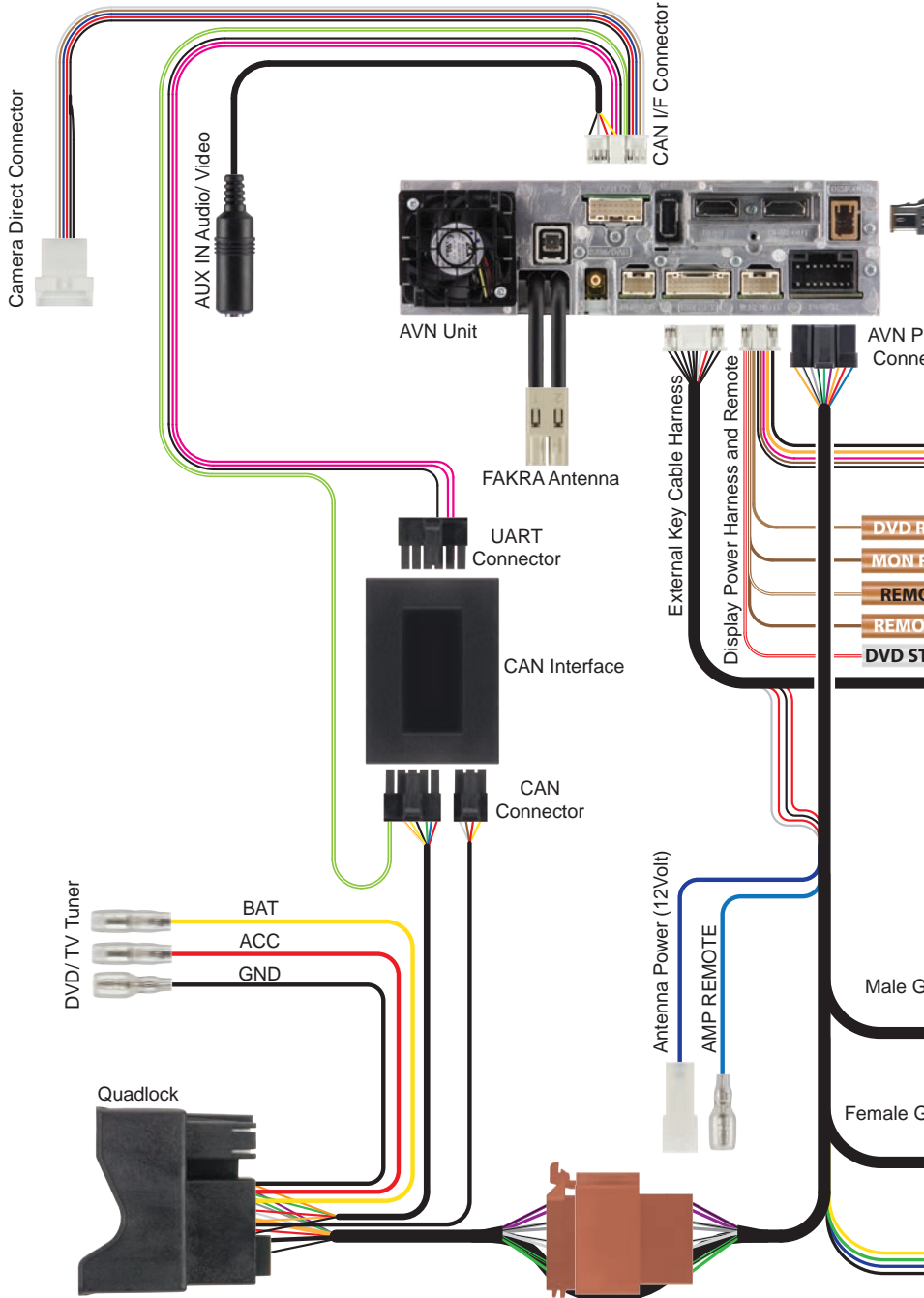

e/ Raccordements/ nti

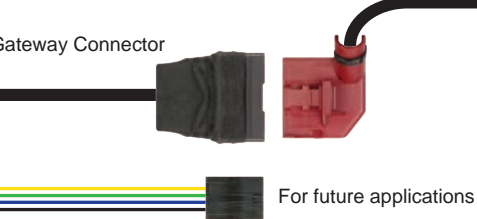
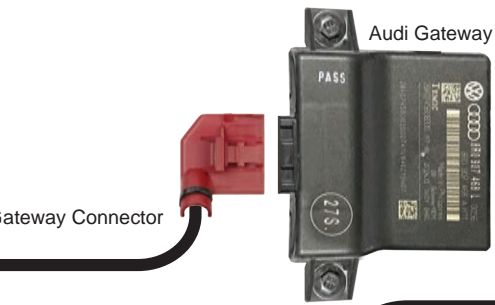
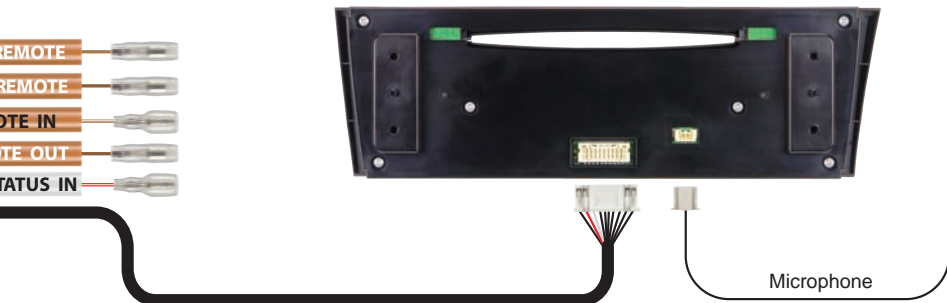
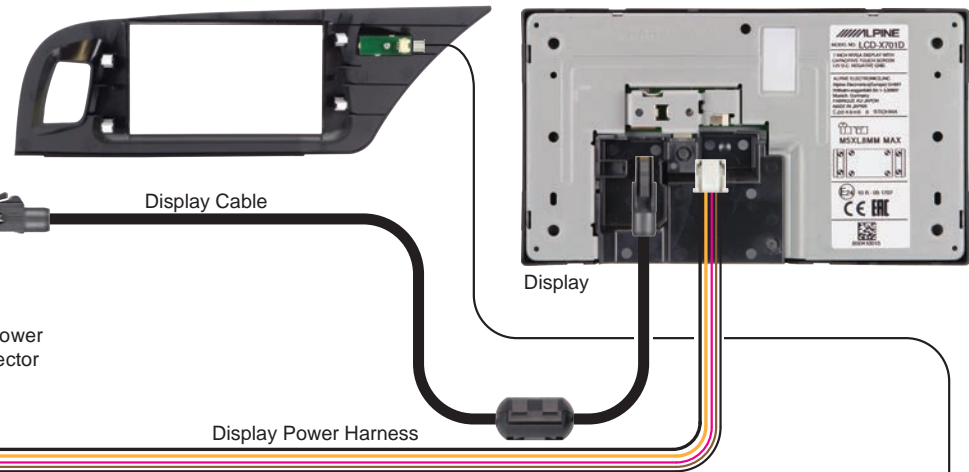

Steering Wheel Remote Control/ Lenkradfernbedienung/ Commandes au volant/ Comandi al volante/ Control remoto del volante

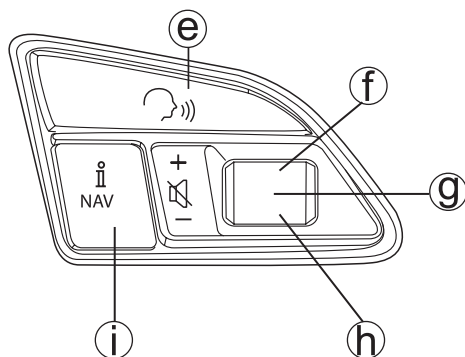
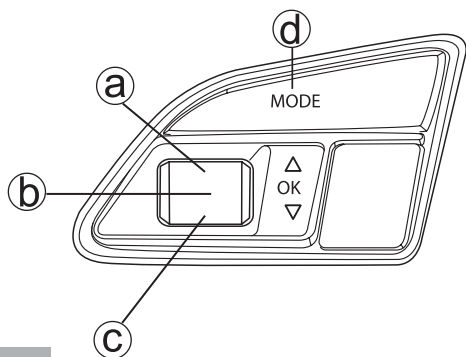
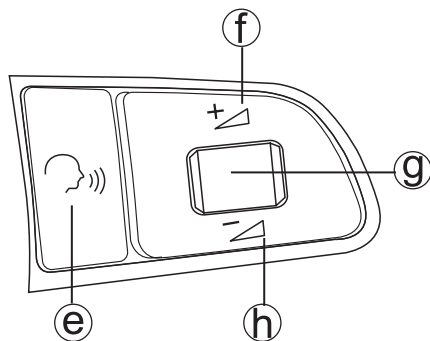
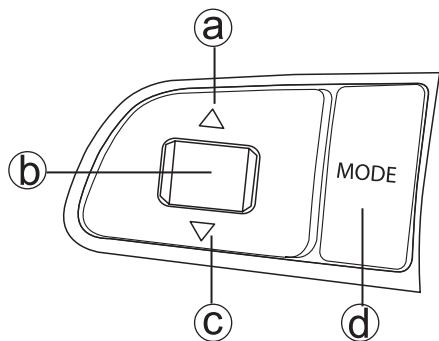

EN

Button	Radio (DAB/ FM/ MW/ LW)	iPod/ USB Play- back/ BT Audio	AUX/ HDMI/ CD/ DVD	Incoming Call	Active Call
a	Down	Up	-	-	-
b	Short	Phone	Phone	Pick Up	-
	Long	-	-	Reject	Hang Up
c	Up	Down	-	-	-
d	Source	Source	Source	Source	Source
e	Siri/ Voice Dial	Siri/ Voice Dial	Siri/ Voice Dial	Siri/ Voice Dial	Siri/ Voice Dial
f	Vol +	Vol +	Vol +	Vol +	Vol +
g	Mute	Mute	Mute	Mute	Mute
h	Vol -	Vol -	Vol -	Vol -	Vol -
i	Navigation	Navigation	Navigation	Navigation	Navigation

DE

Taste	Radio (DAB/ FM/ MW/ LW)	iPod/ USB Play- back/ BT Audio	AUX/ HDMI/ CD/ DVD	Eingehender Anruf	Aktiver Anruf	
Ⓐ	Ab	Auf	-	-	-	
Ⓑ	Kurz	Telefon	Telefon	Telefon	Abheben	-
	Long	-	-	-	Abweisen	Auflegen
Ⓒ	Auf	Ab	-	-	-	
Ⓓ	Quelle	Quelle	Quelle	Quelle	Quelle	
Ⓔ	Sprachsteuerung (Telefon)	Sprachsteuerung (Telefon)	Sprachsteuerung (Telefon)	Sprachsteuerung (Telefon)	Sprachsteuerung (Telefon)	
Ⓕ	Lauter	Lauter	Lauter	Lauter	Lauter	
Ⓖ	Stummschalten	Stummschalten	Stummschalten	Stummschalten	Stummschalten	
Ⓗ	Leiser	Leiser	Leiser	Leiser	Leiser	
Ⓘ	Navigation	Navigation	Navigation	Navigation	Navigation	

FR

Touche	Radio (DAB/ FM/ MW/ LW)	iPod/ USB Play- back/ BT Audio	AUX/ HDMI/ CD/ DVD	Appel Entrant	Appel Actif	
Ⓐ	Recherche arrière	Recherche avant	-	-	-	
Ⓑ	Court	Téléphone	Téléphone	Téléphone	Décrocher	-
	Long	-	-	-	Rejeter	Raccrocher
Ⓒ	Recherche avant	Recherche arrière	-	-	-	
Ⓓ	Source	Source	Source	Source	Source	
Ⓔ	Commande vocale du télé- phone	Commande vo- cale du téléphone	Commande vo- cale du téléphone	Commande vo- cale du téléphone	Commande vocale du télé- phone	
Ⓕ	Vol +	Vol +	Vol +	Vol +	Vol +	
Ⓖ	Coupure du son	Coupure du son	Coupure du son	Coupure du son	Coupure du son	
Ⓗ	Vol -	Vol -	Vol -	Vol -	Vol -	
Ⓘ	Navigation	Navigation	Navigation	Navigation	Navigation	

Steering Wheel Remote Control/ Lenkradfernbedienung/ Commandes au volant/ Comandi al volante/ Control remoto del volante

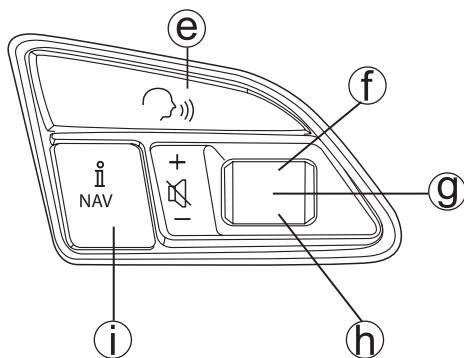
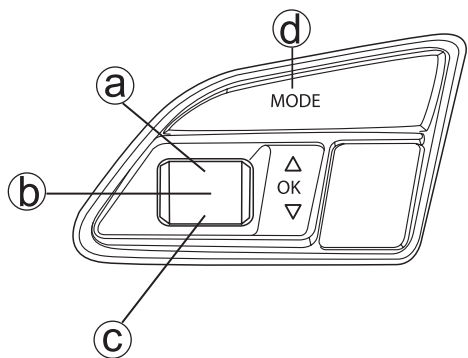
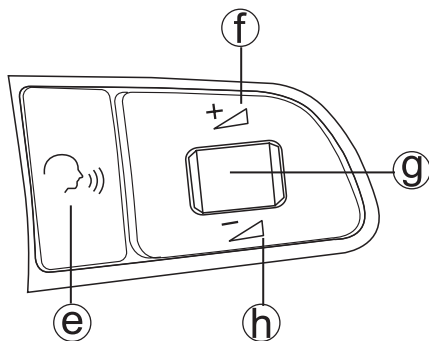
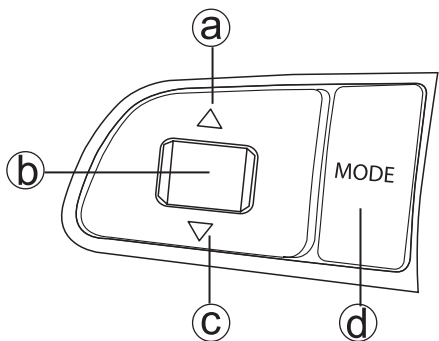

IT

Pulsante	Radio (DAB/ FM/ MW/ LW)	iPod/ USB Play- back/ BT Audio	AUX/ HDMI/ CD/ DVD	Chiamata in arrivo	Chiamata attiva
Ⓐ	Ricerca giù	Ricerca su	-	-	-
Ⓑ	Breve	Telefono	Telefono	Telefono	Accettazione
	Lungo	-	-	-	Rifiuto
Ⓒ	Ricerca su	Ricerca giù	-	-	-
Ⓓ	Sorgente	Sorgente	Sorgente	Sorgente	Sorgente
Ⓔ	Comando vocale a telefono	Comando vocale a telefono	Comando vocale a telefono	Comando vocale a telefono	Comando vocale a telefono
Ⓕ	Volume +	Volume +	Volume +	Volume +	Volume +
Ⓖ	Silenziamento	Silenziamento	Silenziamento	Silenziamento	Silenziamento
Ⓗ	Volume -	Volume -	Volume -	Volume -	Volume -
Ⓘ	Navigation	Navigation	Navigation	Navigation	Navigation

ES

Botón	Radio (DAB/ FM/ MW/ LW)	iPod/ USB Play- back/ BT Audio	AUX/ HDMI/ CD/ DVD	Llamada en- trante	Llamada activa
Ⓐ	Búsqueda hacia abajo	Búsqueda hacia arriba	-	-	-
Ⓑ	Corta	Teléfono	Teléfono	Teléfono	Descolgar
	Larga	-	-	-	Rechazar
Ⓒ	Búsqueda hacia arriba	Búsqueda hacia abajo	-	-	-
Ⓓ	Fuente	Fuente	Fuente	Fuente	Fuente
Ⓔ	Comando de voz para teléfono	Comando de voz para teléfono	Comando de voz para teléfono	Comando de voz para teléfono	Comando de voz para teléfono
Ⓕ	Vol +	Vol +	Vol +	Vol +	Vol +
Ⓖ	Silenciador	Silenciador	Silenciador	Silenciador	Silenciador
Ⓗ	Vol -	Vol -	Vol -	Vol -	Vol -
Ⓘ	Navegación	Navegación	Navegación	Navegación	Navegación

Car Settings/ KFZ Einstellungen/ Réglages Vehicule/ Ajustes vehículo/ Impostazioni del veicolo

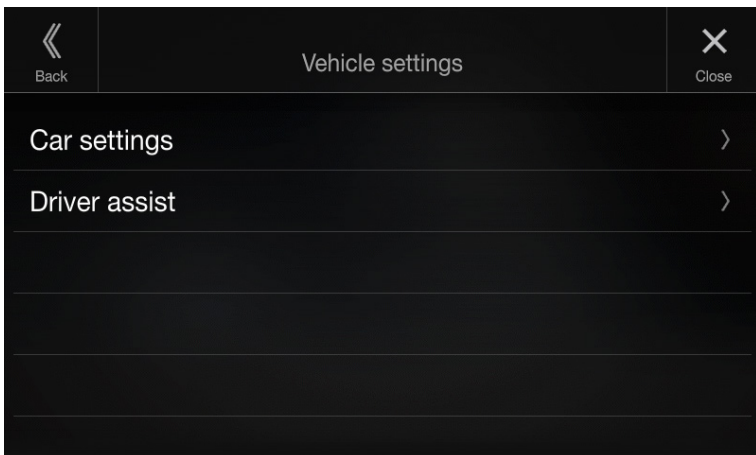
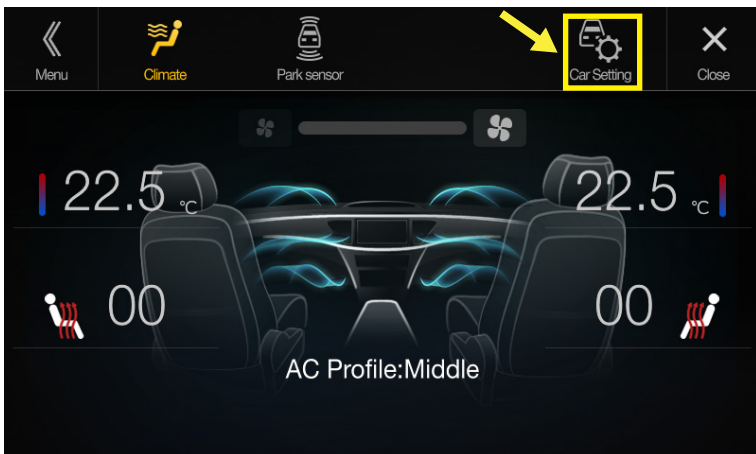



Designed by Alpine Electronics (Europe) GmbH
Printed in Germany

**ALPINE ELECTRONICS
MARKETING, INC.**

1-7, Yukigaya-Otsukamachi, Ota-ku,
Tokyo 145-0067, JAPAN
Phone: 03-5499-4531

**ALPINE ELECTRONICS OF
AMERICA, INC.**

19145 Gramercy Place
Torrance, California 90501 U.S.A.
Phone: 1(310)326-8000

**ALPINE ELECTRONICS OF
AUSTRALIA PTY. LTD.**

161-165 Princes Highway, Hallam
Victoria 3803, Australia
Phone: 61 (3)8787-1200

ALPINE ELECTRONICS GmbH
Ohmstr. 4

85716 Unterschleißheim, Germany
Phone: 49(0)89-324264-0

**ALPINE ELECTRONICS OF U.K. LTD. ALPINE ELECTRONICS DE ESPAÑA,
S.A.**

Alpine House Earplace Business Park,
Fletchamstead Highway,
Coventry CV4, 9TW, U.K.
Phone: 44-2476-719500

Portal de Gamarra 36, Pabellón 32
01013 Vitoria (Álava). APDO. 133, Spain
Phone: 34 (945) 283588

**ALPINE ELECTRONICS FRANCE
S.A.R.L.**

184 allée des Erables
CS 52016 - Villepinte
95 945 Roissy CDG cedex, France Phone:
33 1 48 63 89 89

**ALPINE ELECTRONICS OF ASIA
PACIFIC CO., LTD**

555 Rasa Tower 1, Unit 2601-2602, 26th
floor
Phaholyothin Road, Chatuchak
Bangkok 10900, Thailand
Phone: 662-937-0505